



INTELLISPEC™ 8
Channel Cluster Box
Addendum Series 6

MANUAL PART NUMBER: 82577 REV. 01

HARDWARE MODEL NUMBER(S): 79660

Copyright Notice / Contact Us

© 2021 Pressco Technology Inc. All rights reserved.

No part of this manual may be reproduced or transmitted in any form or by any means, electronic or mechanical, including photocopying and recording, for any purpose, without the express written permission of Pressco Technology Inc.

The contents of this manual are furnished for informational use only, are subject to change without notice, and should not be construed as a commitment by Pressco Technology Inc.

Written and designed at:

Pressco Technology Inc. World Headquarters

29200 Aurora Road

Cleveland, OH USA 44139-1847

TEL +1-440-498-2600

FAX +1-440-498-2615

www.pressco.com

Business Hours: Monday - Friday, 8:00am - 5:00pm Eastern Time

Customer Support:

Request technical support and remote support: techsupport@pressco.com

24/ 7 Customer Support (for urgent system help): +1-440-498-2000

e-mail: Schedule a service visit: dispatch@pressco.com

Request technical support and remote support: techsupport@pressco.com

Customer Service Fax: +1-440-498-4761

Table of Contents

- Chapter 1 Pressco Introduction 5
 - About This Manual 5
 - Safety Considerations 6
 - Static Discharge Protection 6
- Chapter 2 Safety Information 7
 - Health Warning - Photosensitive Epilepsy 7
 - Symbols Used With This System 8
 - Arc Welding Warning 9
 - Label Description - Intellispec 9
 - Warning Devices 10
 - Light Tree 10
 - Residual Risk 10
 - Intended Use 10
 - Prohibited Use 10
 - Personal Protective Equipment 11
 - Personnel Safety 11
 - Lifting Heavy Objects 12
 - Authorized Users 13
 - Spare Parts Usage 13
- Chapter 3 System Specifications 15
 - Environmental Conditions 15
 - Measurements 8 Channel Cluster Box S6 15
 - Electrical Specifications 8 Channel Cluster Box S6 16
 - Sound Pressure Level 16
- Chapter 4 Installation 17
 - Shipping and Handling 17
 - Recommendations Prior to Installation 17

Assembly, Location, and Mounting Requirements	18
Installation	19
Commissioning	20
Chapter 5 Eight Channel Cluster Box S6	21
Included Components 8 Channel Cluster Box S6	21
8 Port Input - Output Box	21
Servicing the Cluster Box	22
Replacing Fuses in the 8 Channel Cluster Box S6	22
Chapter 6 Wiring Diagrams 8 Channel Cluster Box S6	24
Wiring Diagram 8 Channel Cluster Box Sheet 1 of 4	25
Wiring Diagrams 8 Channel Cluster Box 2 of 4	26
Wiring Diagrams 8 Channel Cluster Box 3 of 4	27
Wiring Diagrams 8 Channel Cluster Box 4 of 4	28
Chapter 7 Maintenance for the Cluster Box	30
Maintenance Cautions	30
Clean the Cluster Box Filters	30

Chapter 1 Pressco Introduction

Welcome!

Congratulations on your purchase of an Intellispec system! The Intellispec is a high-speed machine vision system designed specifically for product and online process monitoring. It is a powerful tool that provides inspection much more reliably than the human eye or sampling methods. The latest PC technology, powerful inspection algorithms, online adjustment capability, and inspection data storage allow the Intellispec to automatically inspect parts with extreme accuracy on high-speed lines.

The Intellispec will help you provide the highest quality of products shipped to your customers.

About This Manual



IMPORTANT: *Keep this manual for future reference*

This manual discusses the entire Intellimass system, including the software interface and the hardware. Installation, troubleshooting, and maintenance information is provided in specific chapters.

We recommend a formal training class either in our classroom facilities in Cleveland, Ohio USA, or on-site at your facility. Please contact Pressco's training department for information about classes. This manual should be used as a reference after you have received training.

Related books include:

- Intellispec Operator's Guide which has Operator-level user instructions, and is a good place to start if you are new to Intellispec
- Intellispec Software Guide which has Administrator-level user instructions
- Intellispec Hardware Guide (multiple options), which describes the vision processor and cabinet

The following types of alerts may appear in this guide:



DANGER! - Danger messages alert you to specific conditions that can cause serious or fatal personal injury. Danger messages give you important information which must be observed to prevent injury.



WARNING: - Warning messages indicate information which must be observed to prevent injury, data loss, or equipment damage.



CAUTION - Caution messages indicate important information which must be observed to prevent: loss of data, poor system performance, or equipment damage.

Note: Notes contain special information that warrants being set off from the body text as shown here.



IMPORTANT - Indicates prerequisites or information that must be observed to complete or understand a concept or task.

TIP: Provides helpful hints for completing a task.

Safety Considerations

Observe the following safety warnings when operating the system or working near it:



WARNING - Potential for projectiles to strike persons and cause injury. Keep clear of reject devices.



WARNING - Sensitive electronics and High Voltages may be exposed. Keep Processor Cabinet/ Electrical Control Box door closed.

Static Discharge Protection



Caution - Electronic components can be damaged by static electricity discharge.

Always observe the following precautions before removing, installing or handling any electronic components within the Inspection System:

- Wear an anti-static wristband which is grounded to the Inspection System.
- Stand on an anti-static, grounded floor mat, and lay circuit boards on the mat during any board replacement.
- Keep circuit boards in static shield bags when storing and transporting. Ensure the bag is sealed.

Chapter 2 Safety Information

This section contains operator safety information that must be read before operating or servicing the system.

 **WARNING** - This product contains no operator serviceable parts. Refer servicing to qualified personnel. To prevent electrical shock do not open cabinet doors whilst power is connected.

 **WARNING** - Do not, under any circumstances, tamper with sealed machine parts or devices. This could result in the removal of protections that might create potentially hazardous conditions.

 **CAUTION** - Possible hazardous optical radiation from LEDs. Do not stare at lamps.

Health Warning - Photosensitive Epilepsy

 **WARNING: PHOTSENSITIVE EPILEPSY/ SEIZURES**

A small percentage of individuals may experience epileptic symptoms or seizures when exposed to certain patterns or flashing lights. Exposure to the flashing lights in vision inspection systems may also trigger epileptic symptoms or seizures in these individuals. These flashing lights may trigger epileptic symptoms or seizures in persons who have no history of epileptic symptoms or seizures. If you, or anyone in your family has an epileptic condition or has had seizures of any kind, consult your physician before operating this machinery.

IMMEDIATELY DISCONTINUE use and consult your physician if you experience any of the following symptoms while operating this machinery:

- Dizziness
- Altered vision
- Eye or muscle twitches
- Loss of awareness
- Disorientation
- Seizures
- Any involuntary movement or convulsion

Epileptic symptom or seizure triggers vary from person to person. Some common triggers are:











- Flashing lights used for vision inspection systems or fire alarms
- Certain video games or TV broadcasts containing rapid flashes or alternating patterns of different colors
- Bright, contrasting patterns such as white bars against a black background
- Flashing white light followed by darkness
- Stimulating images that take up your complete field of vision, such as being very close to a TV screen or computer monitor
- Certain colors, such as red and blue

If you encounter something that might trigger epileptic symptoms or seizures without warning:

- Do not close your eyes (this could cause a flicker effect)
- Do not look directly at the flashing lights or trigger source
- Do cover one eye with the palm of your hand immediately
- Do turn away from the flashing lights or trigger source

Symbols Used With This System

The following symbols are used on or near the Pressco system. Be aware of potential risk hazards.

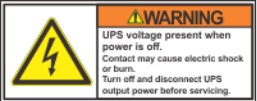
Symbol	Meaning
	CAUTION: Risk of danger. Refer to accompanying user documentation before use.
	WARNING: Risk of electric shock
	WARNING: Arc flash and shock hazard
	WARNING: Risk of electrical shock
	WARNING: Risk of burns from hot surface
	WARNING: Hand crush hazard
	On (supply)
	Off (supply)
	Alternating current
	Protective conductor terminal
	Warning: Arc flash and shock hazard
	Warning: UPS voltage present when power is off

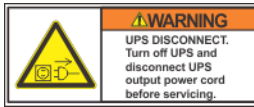

Warning: UPS Disconnect

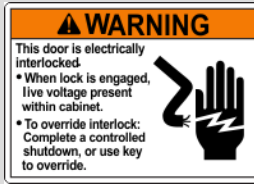

Warning: Electrical interlock



Danger: shock and arc flash explosion hazards

Arc Welding Warning

⚠ WARNING - Potential equipment damage can occur if the vision equipment is not fully powered down prior to any arc welding performed on the line where the vision equipment is installed, specifically but not limited to our encoders.

Label Description - Intellispec

The following illustration shows an example label that you will find on the Intellispec system components.

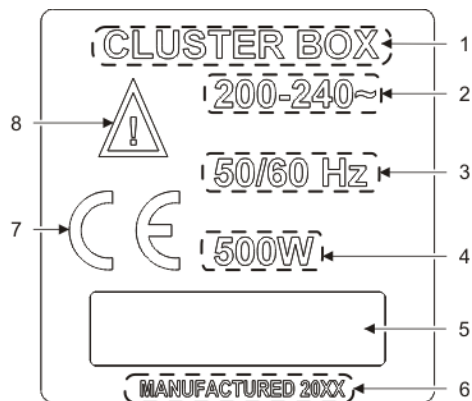

- 1) Name of component. NOTE: The Chromapulse model is listed on the front panel of the module.
- 2) Voltage range in Volts AC
- 3) Frequency range in Hertz (Hz)
- 4) Maximum rated power in watts (W) with all accessories or plug-in modules connected
- 5) Serial number is listed in this box
- 6) Year of manufacture
- 7) Component certification
- 8) Risk of danger. Refer to accompanying documentation before use.

Warning Devices

The Pressco system has warning devices that indicate system failure or report excessive defects or warnings for your production line. These include an optional light tree, alarms and indicators on screen, and audible warnings (depending on system).

Light Tree

The optional light tree is mounted on a pole in a customer-specified location.



The light tree color segments represent each alarm or system condition. A color segment may appear for more than one alarm condition.

Residual Risk

The Pressco system has been designed to minimize any danger of personal injury. However, the system uses rejection devices to remove defective product from the production stream. Also, the electronics cabinets contain risk of shock if they are opened.

Observe the following safety warnings when operating the system or working near it:



WARNING - Potential for projectiles to strike persons and cause injury. Keep clear of reject devices.



WARNING - Sensitive electronics and High Voltages may be exposed. Keep Processor Cabinet/ Electrical Control Box door closed.

Intended Use

Type of Process The Pressco system is intended to monitor container and other special manufacturing processes and identify non-conforming product.

Intended Use The Pressco system is designed and constructed for use in an indoor industrial environment, always sheltered from the weather.

Space Required The Pressco system and accompanying sensors must be installed in a place that will enable safe and easy installation, size changeover, user operation, and maintenance procedures.

Prohibited Use



WARNING - If this instrument is not used as specified, the protection provided by the equipment could be impaired. This instrument must only be used in a normal condition (in which all means of protection are intact).



Important - The Pressco system should NOT be used for any purpose other than specifically indicated in the section titled "**Intended Use**" above.

The following uses are not intended:



Use in an explosive environment



Use in a flammable environment



Use in a damp, moist, or wet environment, except where specifically indicated

Personal Protective Equipment



Important - Always follow the safety requirements of your plant in addition to the recommendations below.

We recommend, at minimum, use of the following Personal Protective Equipment (PPE):



Protective clothing



Protective gloves



Protective ear plugs or headphones



Protective eye wear



Protective foot wear

Personnel Safety

The following rules are recommended to ensure the safety of personnel in charge of machine operation and maintenance.

During machine operation:



Only one operator is needed to operate the machine. All others must keep at a safe distance.



Operators must be familiar with all machinery connected to the Pressco equipment and know how to use emergency stop devices.

Note: the emergency stop devices may not be connected directly to the Pressco equipment, but it is important to know how to use them.



Before putting the Pressco system online, the operator must ensure that all safety devices used with all connected machinery are in place and operational.

Do not operate with guards removed.



The operator must maintain maximum focus on his work and be alert throughout his shift. If this is not the case, immediately inform the shift supervisor.

When carrying out maintenance or repair work:



Disconnect master switch. For switch locations, refer to the Power Up and Power Down section.



Before starting the machine, ensure that no person is close to the machine.



If maintenance or repair requires the disconnection or removal of safety or protection systems, this operation must be supervised by authorized personnel who must ensure the prevention of personal injury or damage to the machine. All machine movements must be performed with limited speed and limited movements.



Maintenance or repair work on electrical components must be carried out exclusively by authorized, trained personnel. When running tests with power connected, you must strictly comply with the rules provided.



Personnel working on higher parts of a machine must wear a harness and hook it on to the structure and must always move with extreme caution.



Never perform lubrication or maintenance procedures on mechanical parts with the machine running.

For your safety, do not:



Open safety guards during machine operation



Perform maintenance and repair while the system is running



Lean on the machine



Sit on the machine components



Use the machine for purposes other than those listed in this manual



Modify parts of the machine



Allow unqualified personnel to operate or perform maintenance procedures on the machine

Lifting Heavy Objects



CAUTION - Some components are heavy. Take proper precautions to prevent personal injury or damage to equipment. If you are not capable of lifting the object alone, ask a capable person to help lift the object, or use a mechanical lifting device

The components do not have handles to lift the equipment. Be sure to:

- Lift equipment from the bottom - do not use wires, brackets, nor other protrusions
- Keep fingers away from sensor lenses to keep the equipment clean
- Proceed slowly

 **WARNING-** *The Pressco cabinets must NOT be lifted by one person. Use a mechanical lifting device, and ask another person to assist you.*

 Do not twist your body when moving the load. Instead take small steps with your feet turning until you are in the correct position.

To safely lift equipment:

1. Stand close to the load and center yourself over it with your feet shoulder width apart.
2. Tighten your abdominal muscles.
3. Keeping your back straight, bend your knees and squat down to the floor.
4. Get a good grasp on the load with both hands.
5. Keeping the load close to your body, use your leg muscles to stand up lifting the load off the floor. Your back should remain straight throughout lifting, using only the muscles in the legs to lift the load.
6. To place the load in the appropriate spot, bend at the knees using only your leg muscles to lower the load.

Authorized Users

Trained machine operators, mechanic and electrical maintenance staff, and plant managers are considered authorized users of the Pressco system. These users should carefully read the information contained in this manual. The plant manager must ensure that the safety recommendations included in this manual are observed.

 **WARNING -** *Allowing workers who are unfamiliar with the production process to operate the Pressco system could result in hazard risk.*

If you are unclear about any part of this manual, contact Pressco Technical Support.

 **Important -** *No worker should ever operate the system outside of his/ her own area of competence and responsibility.*

Proper Operation: Only one worker is to operate the system at any given time. The correct position for the operator is in front of the user interface monitor or control enclosure (if applicable).

Repairs: Any repair on the system shall be carried out exclusively by Pressco Technology Inc. service personnel or by other service expressly authorized by Pressco Technology Inc.

Spare Parts Usage

The following restrictions apply to replacing parts:

 **WARNING -** *Using spare parts that are not designed to Pressco's specifications can compromise the safety and effectiveness of the Pressco system.*

- The use of parts that are not within Pressco's design specifications is prohibited. This prohibition applies in particular when the parts involved contain or are connected with safety devices.
- Before resuming production, make sure all safety devices are in working order.

Chapter 2

Pressco Technology Inc. shall not be liable in any way if any of the above-described directions are not complied with.

To obtain a spare parts list, contact the customer service department at Pressco.

Pressco's technicians are available to help customers, in their own plant, to solve any problem that might arise during use and maintenance of the system.

Chapter 3 System Specifications

This instrument has been designed and tested in accordance with Publication EN61010-1 (2010) Safety Requirements for Electrical Equipment for Measurement, Control and Laboratory Use and has been supplied in a safe condition. The instruction documentation contains information and warnings which must be followed by the user to ensure safe operation and to maintain the instrument in a safe condition.

Environmental Conditions

The Intellispec system is designed to be safe in the following environmental conditions:

Note: Please consult Pressco Technology Inc. if your environmental conditions are outside of those listed.

Condition	Specifications
Indoor/ outdoor use	Indoor use only
Altitude	Up to 2000 meters
Operating Temperature	5 °C to 50 °C
Storage Temperature	0 °C to 70 °C
Humidity	Maximum relative humidity 80 % for temperatures up to 31 °C decreasing linearly to 50 % relative humidity at 50 °C
Mains supply	Voltage fluctuations up to ± 10 % of the nominal voltage
Overvoltage protection rating	Transient overvoltage typically present on MAINS supply NOTE: the normal level of transient overvoltages is impulse withstand (over-voltage) category II of IEC 60364-4-443.
Rated pollution degree	This instrument is designed for use in Installation Category II and Pollution Degree 1 as per EN61010-1 and EN60664 respectively.



Warning - This is a Class A product. In a domestic environment this product may cause radio interference in which case the user may be required to take adequate measures.

Measurements 8 Channel Cluster Box S6

Dimensions are shown in inches. Dimensions in brackets are in millimeters for reference.

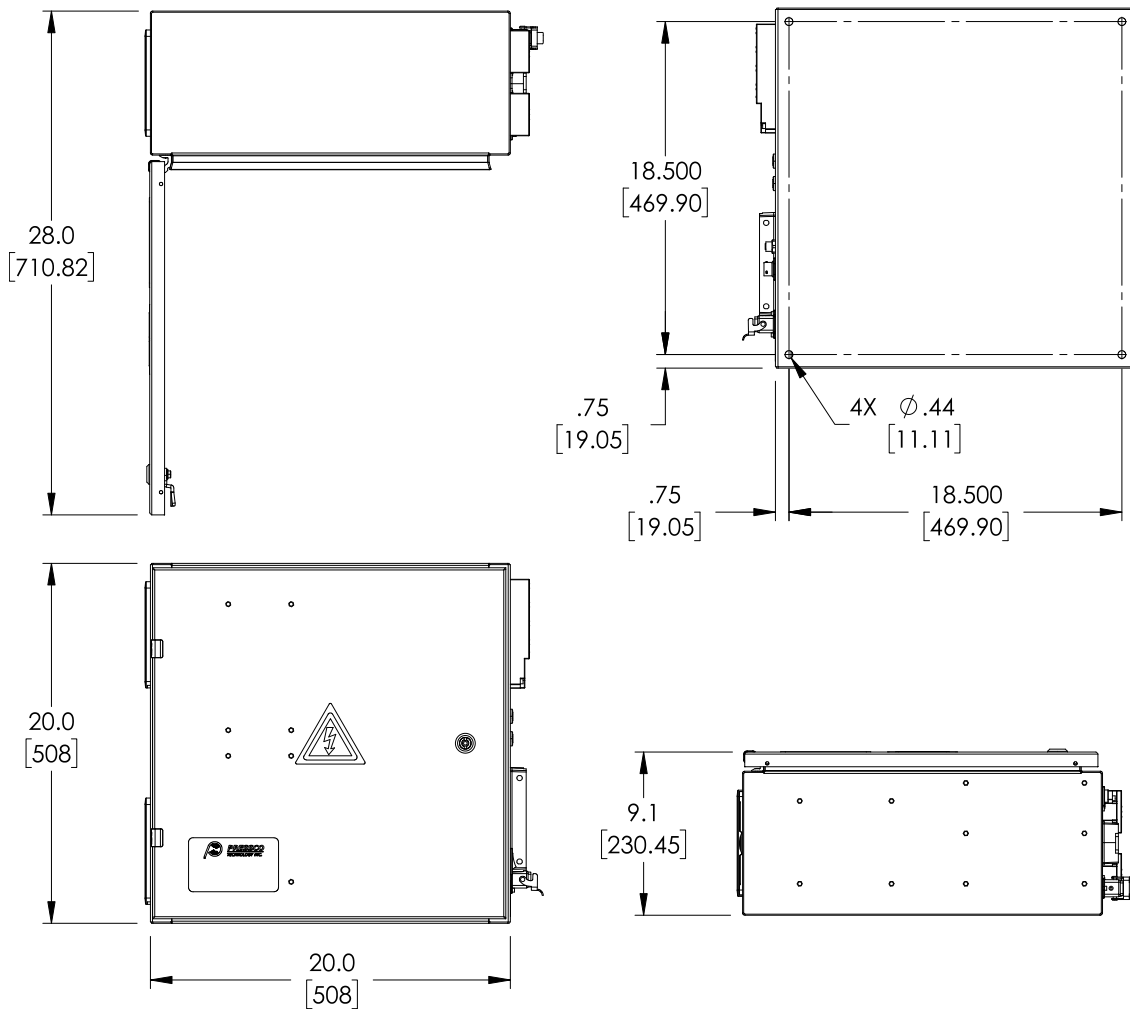

Electrical Specifications 8 Channel Cluster Box S6

The control cabinet provides power to this module.

Input voltage: 60VDC from the control cabinet.

Power: 300W max

Sound Pressure Level

The horn on the optional light tree has a maximum 105dB level at 1 meter distance in front of the horn. Use proper hearing protection as specified by your plant safety instructions.

Chapter 4 Installation

This section contains information about installation requirements and preparations that need to be complete before installing the system.

Shipping and Handling

Pressco Technology Inc. ships unassembled components in packing cases designed to protect the contents during handling and from exposure to weather.

Unless otherwise specified in the contract with the machine order, the Customer shall supply Pressco Technology Inc. with the means and equipment necessary for the unloading, lifting, and handling of machine parts. Pressco Technology Inc. deems it important to have one of their technicians supervise the process of unloading, handling, and lifting the machine. The technician can give useful advice as to the logical sequence in which the components should be unpacked and positioned for ease of assembly.

 **WARNING** - Only qualified personnel must be involved in the operation of unloading, handling, and lifting the machine. Pressco Technology Inc. shall not be liable for damage to components and/or personal injury resulting from the involvement of unauthorized personnel and/or failure to comply with the directions provided in this manual in relation to lifting and transport.

 **Important** - The site supervisor will be responsible for ensuring that all the various mounting phases are carried out safely and in compliance with current regulations.

After the machine is delivered, check for any damage that might have occurred during shipping. In case of damage, contact Pressco Technology Inc.

In handling the machine, always keep it close to the ground.



We recommend using a forklift truck with adequate capacity and forks to suit the weight to be lifted (machine plus packaging).

The dimensions and weight of a crate are listed below. Note that this is the maximum size and weight. The size and weight of the crate may be less depending on your configuration. You may receive multiple crates depending on your configuration.

Size (full Intellispec system)	152.4 cm x 124.46 cm x 152.4 cm (60 x 49 x 60 inches)
--------------------------------	---

Weight (full Intellispec system)	453.592 kg (1000 lbs.)
----------------------------------	------------------------

Weight (CDX6 module)	68 kg (150 lbs.)
----------------------	------------------

Recommendations Prior to Installation

Before the machine is installed, the Pressco installer, together with the Customer (or representative) shall check the following criteria in the environment where the machine is to be installed:

- Work required by contract for the installation of the machine has been carried out
- The plant layout drawing that describes where the machine will be installed is the final drawing agreed to by Pressco Technology Inc.
- The space and height required for installation are actually available
- Only the components included in the installation layout are present in the area where the machine is to be mounted. Ensure no machines or components have been added at a later stage that might hinder mounting or make it more difficult. Should this be the case, immediately contact Pressco's Project Engineering personnel to arrange a suitable solution to the problem.

We recommend the following prior to machine installation:

- Transport the machine in its packaging to the area where it will be installed to minimize possibility of damage
- Carefully remove the packaging material and check components for damage
- Check tightness of mechanical components, as they can loosen during transport
- Prepare the compressed air mains line. Before making final connections, ensure that the pipes are clean and free from any debris.

Assembly, Location, and Mounting Requirements

Utilities to be Supplied by Customer

The following utilities are required to operate the Pressco Intellispec system. Before making connection, make sure the utility matches the technical specifications. More than one connection of the utilities may be required depending on the number of modules installed. Refer to specific wiring diagrams.

Utility	Requirements
Air supply for rejection device	Pipe size must be such that there will be no pressure decrease during machine operation. Air must be dry and free of oil.
Electrical supply	Provide one each electrical socket to comply with: <ul style="list-style-type: none"> • User interface electrical specifications (use the specifications that apply to your system) • Integrated tunnel electrical specifications (if applicable) • Cluster box electrical specifications (if applicable)
Internet connection (optional)	Provide a shielded ethernet cable to use Pressco's remote support through the Internet.

Protective Earthing

This product must be grounded (earthed). If it should malfunction or break down, grounding provides a path of least resistance for electric current to reduce the risk of electric shock.

⚠ DANGER - Improper connection of the equipment grounding conductor can result in a risk of electric shock. Check with a qualified electrician or service technician if you are in doubt as to whether the product is properly grounded.

Cord Connected Equipment

The product will be equipped with a supply cord having an equipment grounding conductor and a grounding plug. The plug must be plugged into an appropriate outlet that is properly installed and grounded in accordance with local codes and ordinances.

Do not modify the plug provided with the product - if it will not fit the outlet, have a proper outlet installed by a qualified electrician.

Cable Direct

This product must be connected to a grounded metal, permanent wiring system, or an equipment grounding conductor must be run with the circuit conductors and be connected to the equipment grounding terminal.

Electrical Connection

Make sure that the power outlet voltage matches the voltage required by the machine. Refer to the electrical specifications and wiring diagrams for your system.

⚠ WARNING - Power Switch is the power disconnect device. Do not position the equipment such that access to the disconnect switch is impaired. If not readily accessible (such as within a rack or mounting out of reach), an additional disconnect device should be installed that can isolate the Live and Neutral lines of the mains power supply, whilst leaving the protective earth intact.

Reject Valve Pneumatic Diagram

This diagram shows the reject device connection to the 8-port I/O box. This is for Intellispec systems.

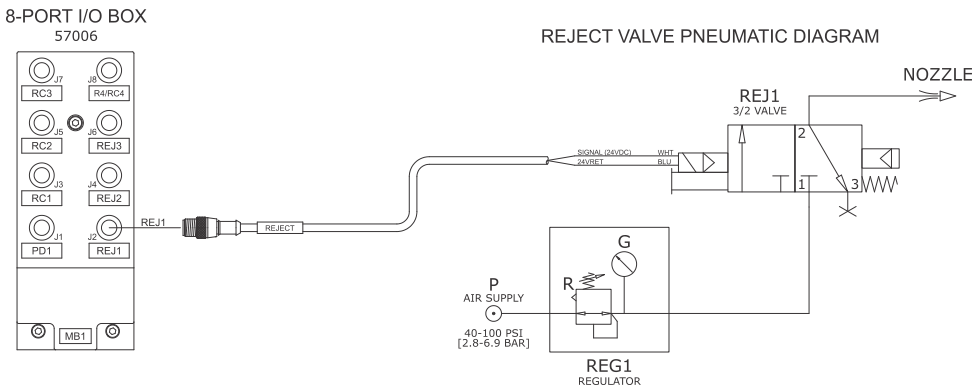

Installation

Pressco Technology Inc. recommends that the machine be installed and assembled by Pressco's specialized technicians. This is of vital importance for correct machine operation.

 **WARNING** - Pressco Technology Inc. shall not be liable in case of failures or damage to property and/or personal injury resulting from or connected with assembly if this has been carried out by unauthorized personnel, or is not in compliance with the indications given in this manual.

To carry out production and cleaning/ servicing operations, it is important for the machine to have a minimum amount of space all around and away from walls.

Ventilation

Place the Pressco Intellispec components in a position with adequate ventilation to allow proper air flow through the air filters.

Component	Spacing
User Interface	Leave 1 meter [39 inches] clear around machine
Cluster box (not used on all systems)	Leave 100 mm clear in front of the fan and vent

Commissioning

Before placing the machine into operation, make sure the following checks are completed:

Completed	Yes	No
Positioning and leveling of the unit		
Connection of compressed air line to connection points		
Connection of power supply to vision processor cabinet		
Connection of power supply to cluster box (if applicable)		
Connection of power supply to integrated inspection module(s) if applicable		
Proper wiring from user interface cabinet to sensor module(s) and cluster box (if applicable) using the wiring diagrams		

Chapter 5 Eight Channel Cluster Box S6

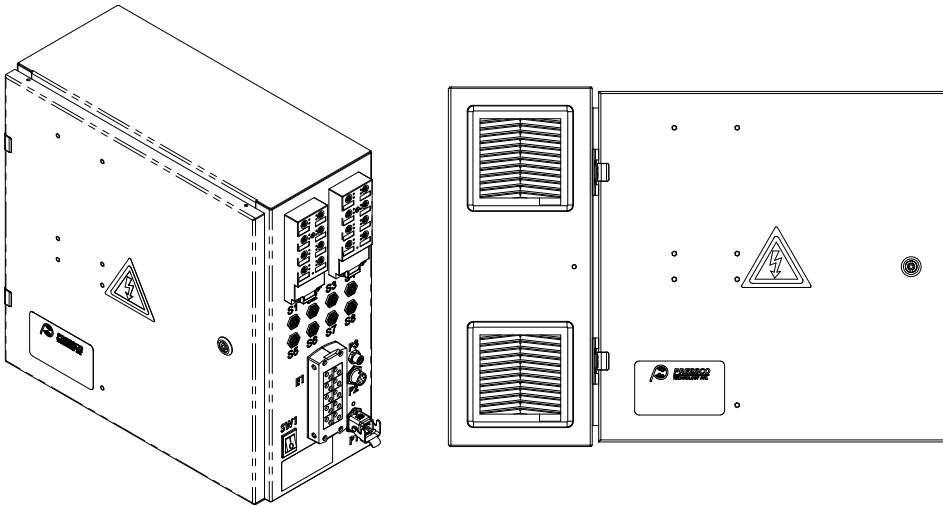

Included Components 8 Channel Cluster Box S6

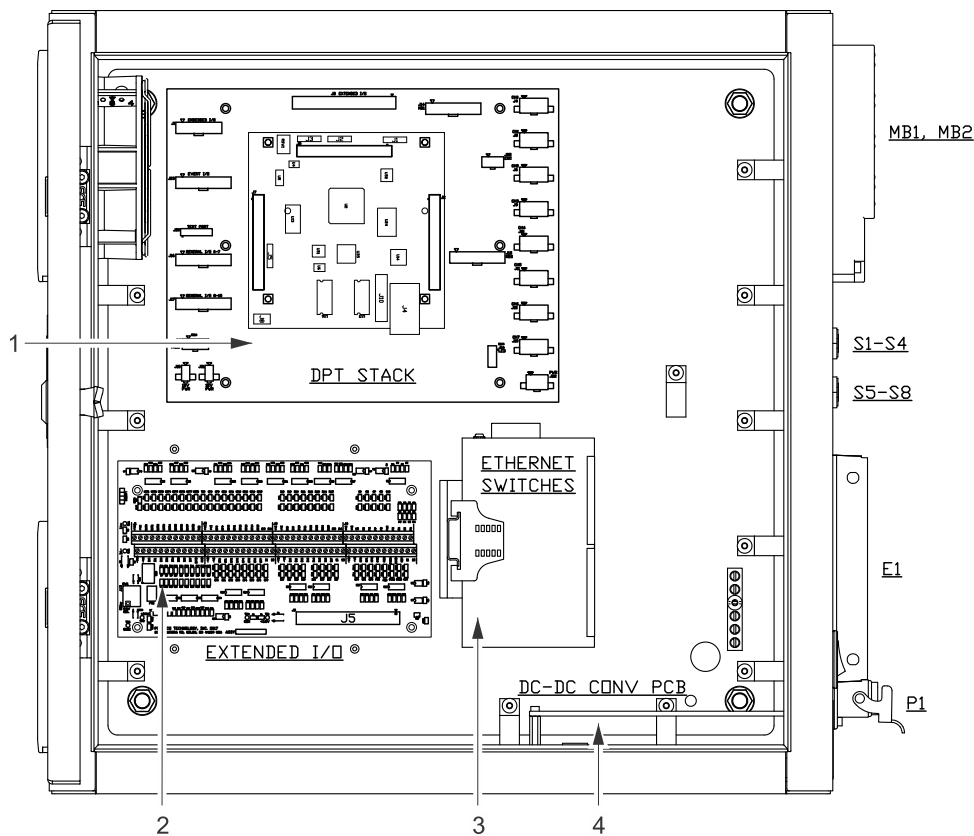

1) 8-channel Part Tracker Assembly

2) Extended I/O Board

3) Ethernet Switches (4 camera + 4 camera)

4) DC - DC Converter board with fuses

8 Port Input - Output Box

These boxes are located on the outside of the cluster box.

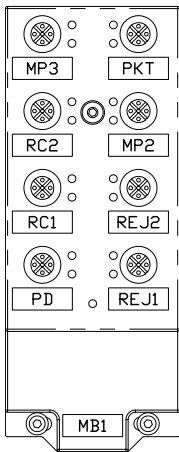



8-Port I/O labels:

- MP - Machine Parts
- PKT - Pocket Detect
- RC - Reject Confirm
- REJ - Rejector
- PD - Part Detect

Servicing the Cluster Box

This instrument has been designed and tested in accordance with Publication EN61010-1 (2010) Safety Requirements for Electrical Equipment for Measurement, Control and Laboratory Use and has been supplied in a safe condition. The instruction documentation contains information and warnings which must be followed by the user to ensure safe operation and to maintain the instrument in a safe condition.

 **WARNING** - This product contains no operator serviceable parts. Refer servicing to qualified personnel. To prevent electrical shock do not open cabinet doors whilst power is connected.

 **CAUTION** - Before switching on this instrument, ensure the power supply voltage is in the specified range.

Replacing Fuses in the 8 Channel Cluster Box S6

The fuses are located on the DC/DC Converter board located at the bottom of the cluster box.

 **WARNING** - For continued protection against fire hazard, replace fuses only with the same type and ratings. The use of other fuses or materials is prohibited.

 **WARNING** - Disconnect the product from the mains supply before replacing the fuse(s).

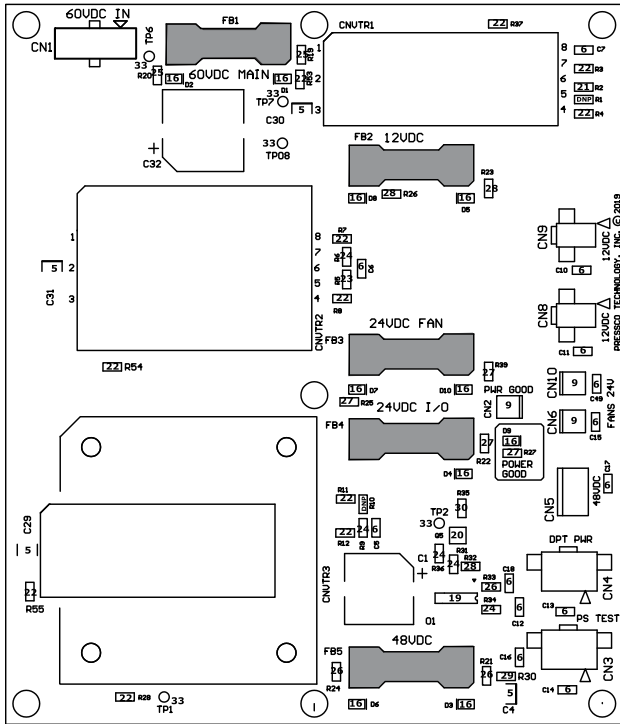

Install Time delay Type 520 fuses :

- FH1: 5 Amp (GMC 5A-R) 75517
- FH2: 5 Amp (GMC 5A-R) 75517
- FH3: 3 Amp (GMC 3A-R) 75519
- FH4: 3 Amp (GMC 3A-R) 75519
- FH5: 4 Amp (GMC 4A-R) 75518

Cooper Bussmann or equivalent

Use kit part number: 78311. This kit contains quantity two (2) each of the fuses below.

Fuse	Part number	Value
FH1, FH2	75517	FUSE 5A 125V 5X20MM TIME DELAY
FH3, FH4	75519	FUSE 3.15A 250V 5X20MM TIME DELAY ROHS COMPLIANT
FH5	75518	FUSE 4A 250V 5X20MM TIME DELAY

Chapter 6 Wiring Diagrams 8 Channel Cluster Box S6

This section is for the 8-channel cluster box for Series 6 Intellispec. Module model number 79660. Wiring diagrams F1920W.

Wiring Diagram 8 Channel Cluster Box Sheet 1 of 4

SEE P/N:
79660

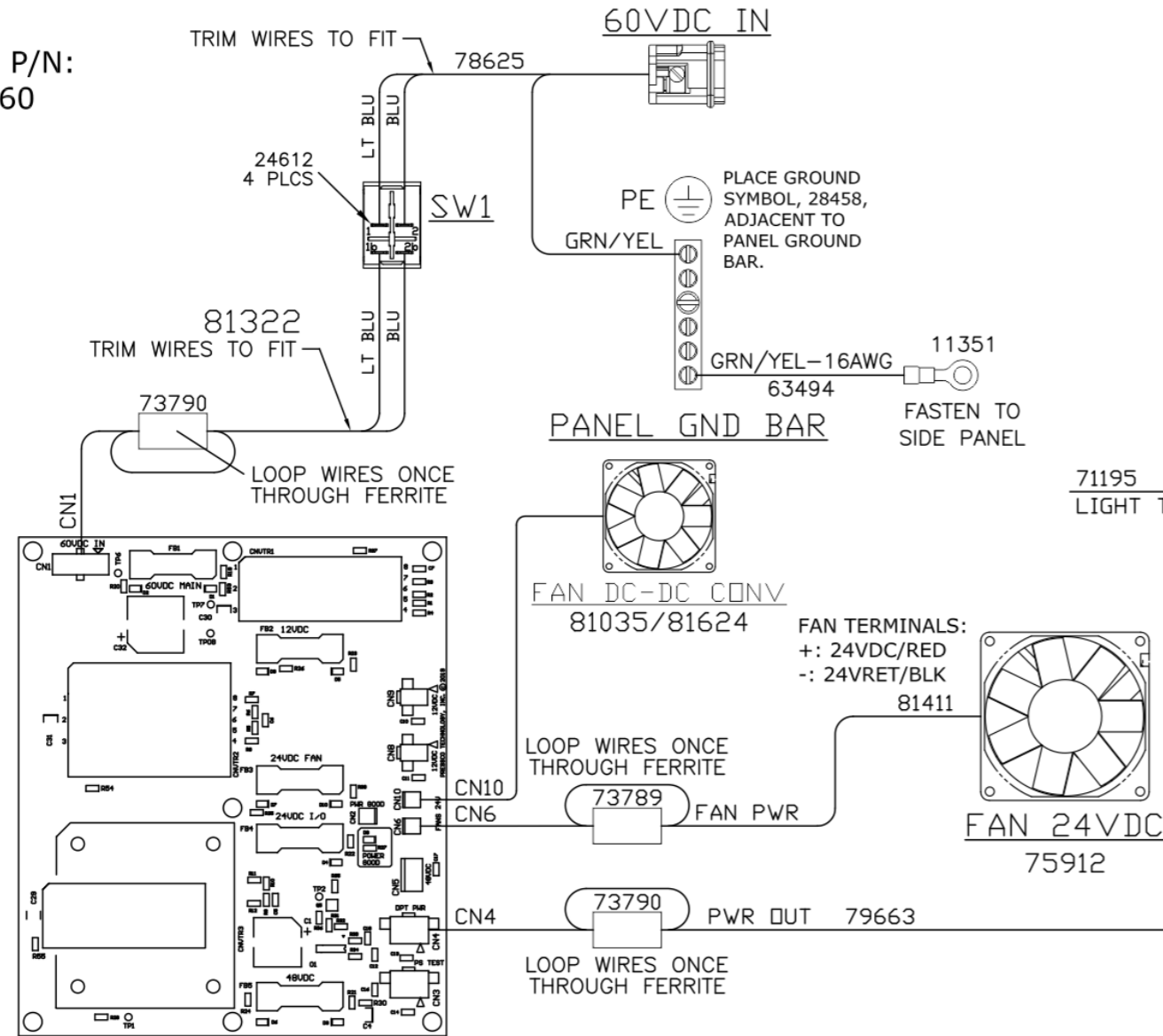

DC-DC CONVERTER PCB
75395

FUSES-75395

- FB1-5A,250V,TIME DELAY
- FB2-5A,250V,TIME DELAY
- FB3-3A,250V,TIME DELAY
- FB4-3A,250V,TIME DELAY
- FB5-4A,250V,TIME DELAY

PLACE ADHESIVE LABEL
WITH FUSE CHART ON
INSIDE OF DOOR.

DC-DC CONVERTER PCB			
FUSE	AMPS	VOLTS	TYPE
FB1	5A	250	5x20mm, TIME DELAY
FB2	5A	250	5x20mm, TIME DELAY
FB3	3A	250	5x20mm, TIME DELAY
FB4	3A	250	5x20mm, TIME DELAY
FB5	4A	250	5x20mm, TIME DELAY

CAUTION: REPLACE FUSES WITH SAME TYPE AND RATING

PART TRACKER PCB ASSY

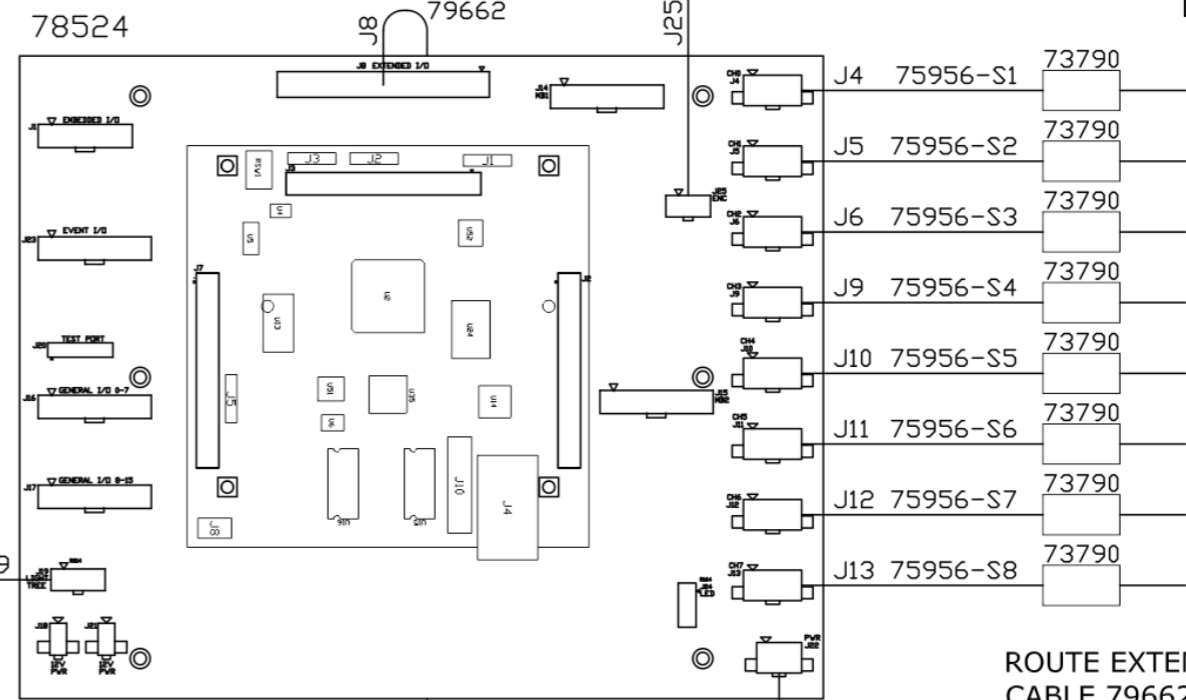

71195 LIGHT TREE

ROUTE EXTENDED I/O
CABLE 79662 UNDER PART
TRACKER AND EXTENDED
I/O BOARDS.

EXTENDED I/O PCB

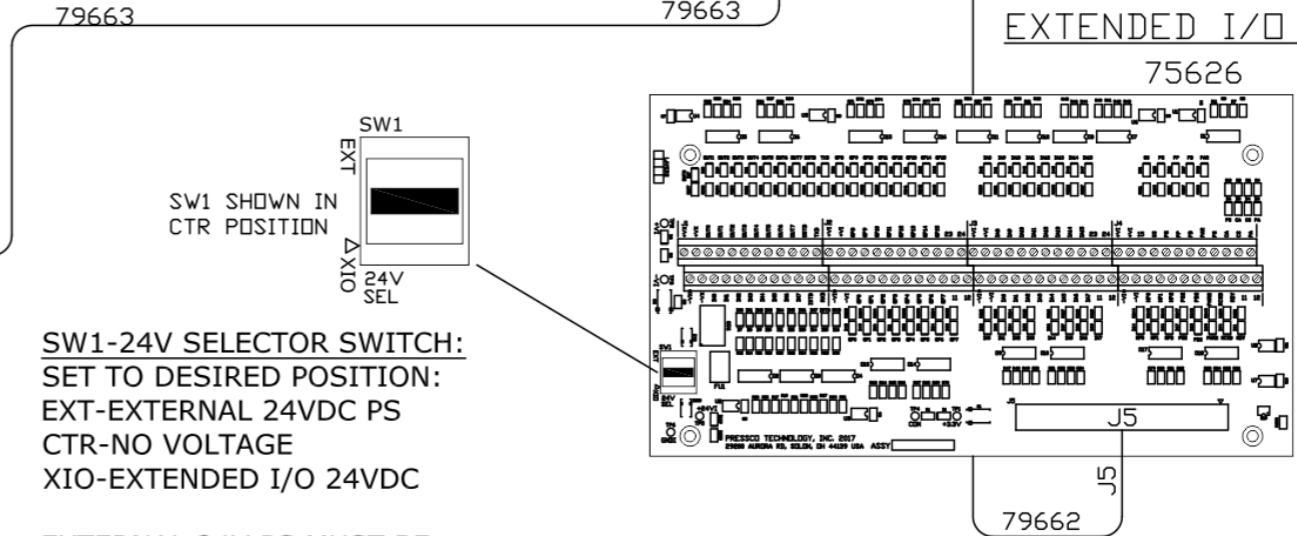

SW1-24V SELECTOR SWITCH:
SET TO DESIRED POSITION:
EXT-EXTERNAL 24VDC PS
CTR-NO VOLTAGE
XIO-EXTENDED I/O 24VDC

EXTERNAL 24V PS MUST BE
CONNECTED TO +VX AND -VX.

NOTE: DO NOT CONNECT
EXTERNAL PS TO +VI OR -VI.

Wiring Diagrams 8 Channel Cluster Box 2 of 4

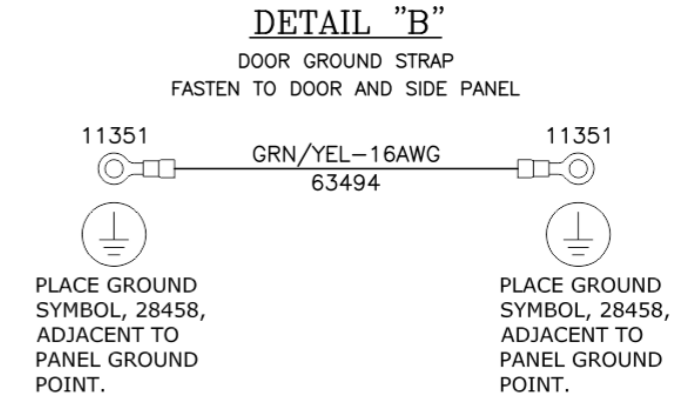
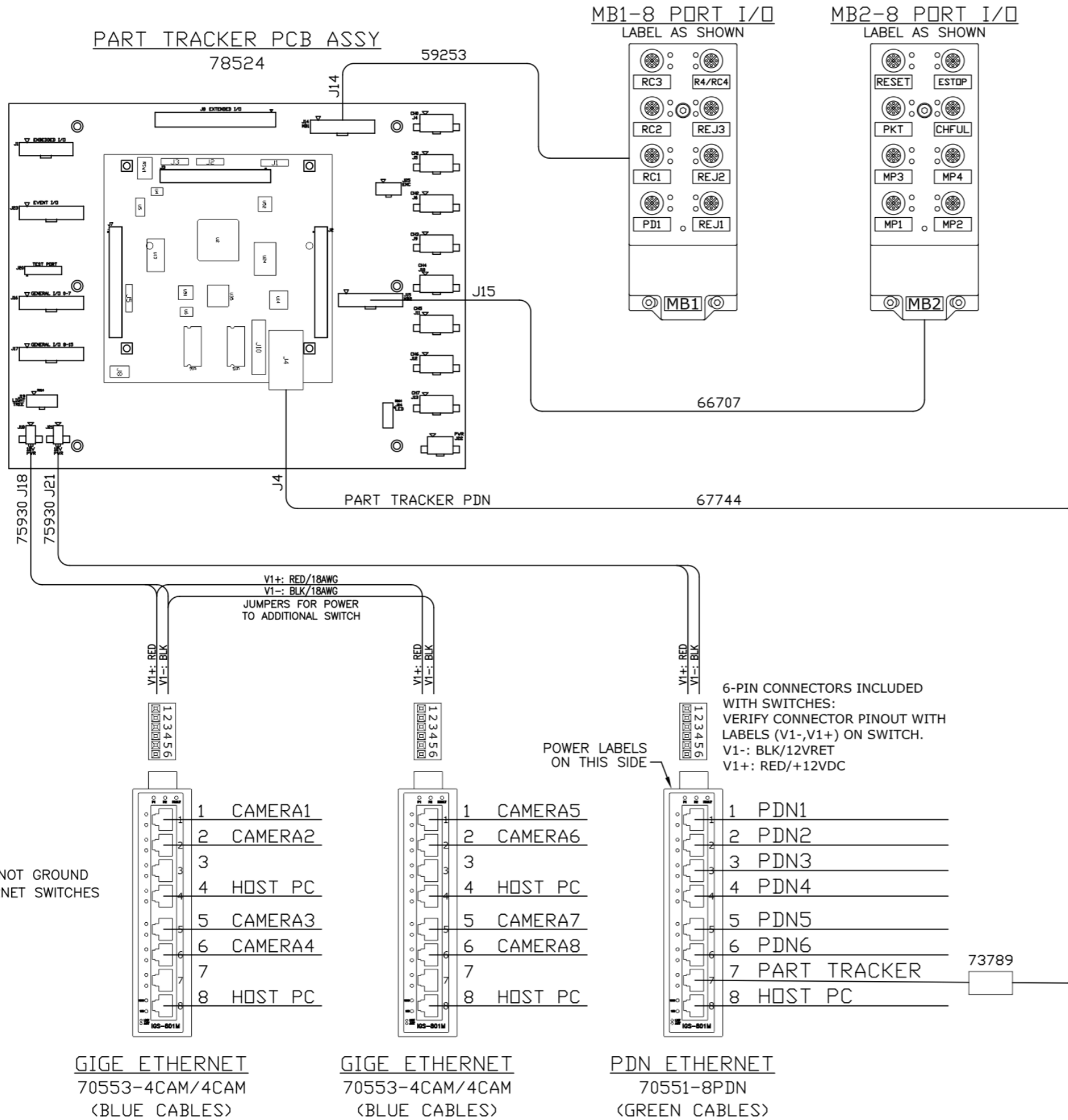

CLUSTER BOX ASSY

SENSORS 1-8

PORTS S1-S8 ARE FOR SENSOR MODULE CONNECTIONS. THESE CONNECTIONS WILL VARY DEPENDING ON THE APPLICATION.

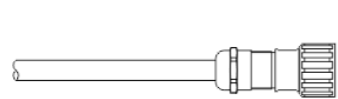

S1

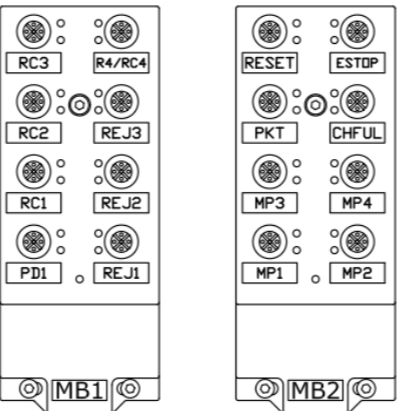

ETHERNET CABLE ENTRY PORTS

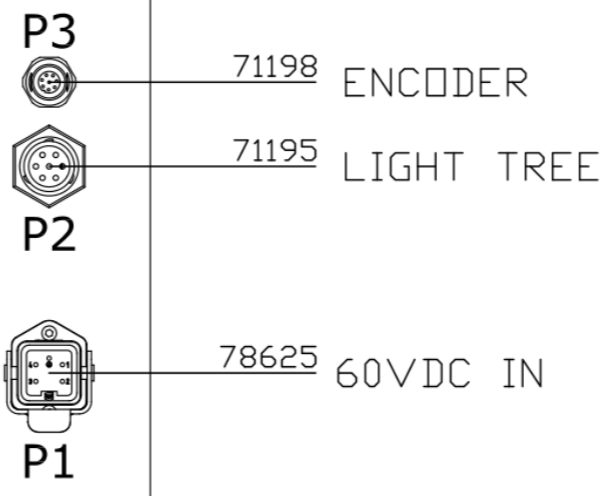
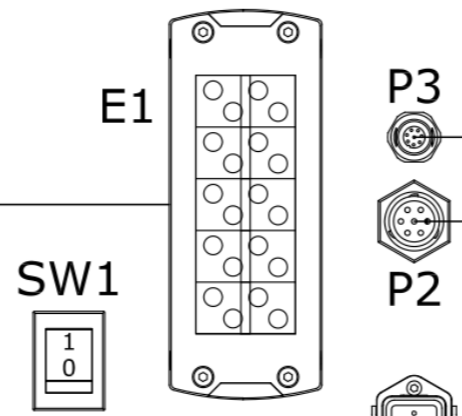

71198 ENCODER
 71195 LIGHT TREE
 78625 60VDC IN

Wiring Diagrams 8 Channel Cluster Box 4 of 4

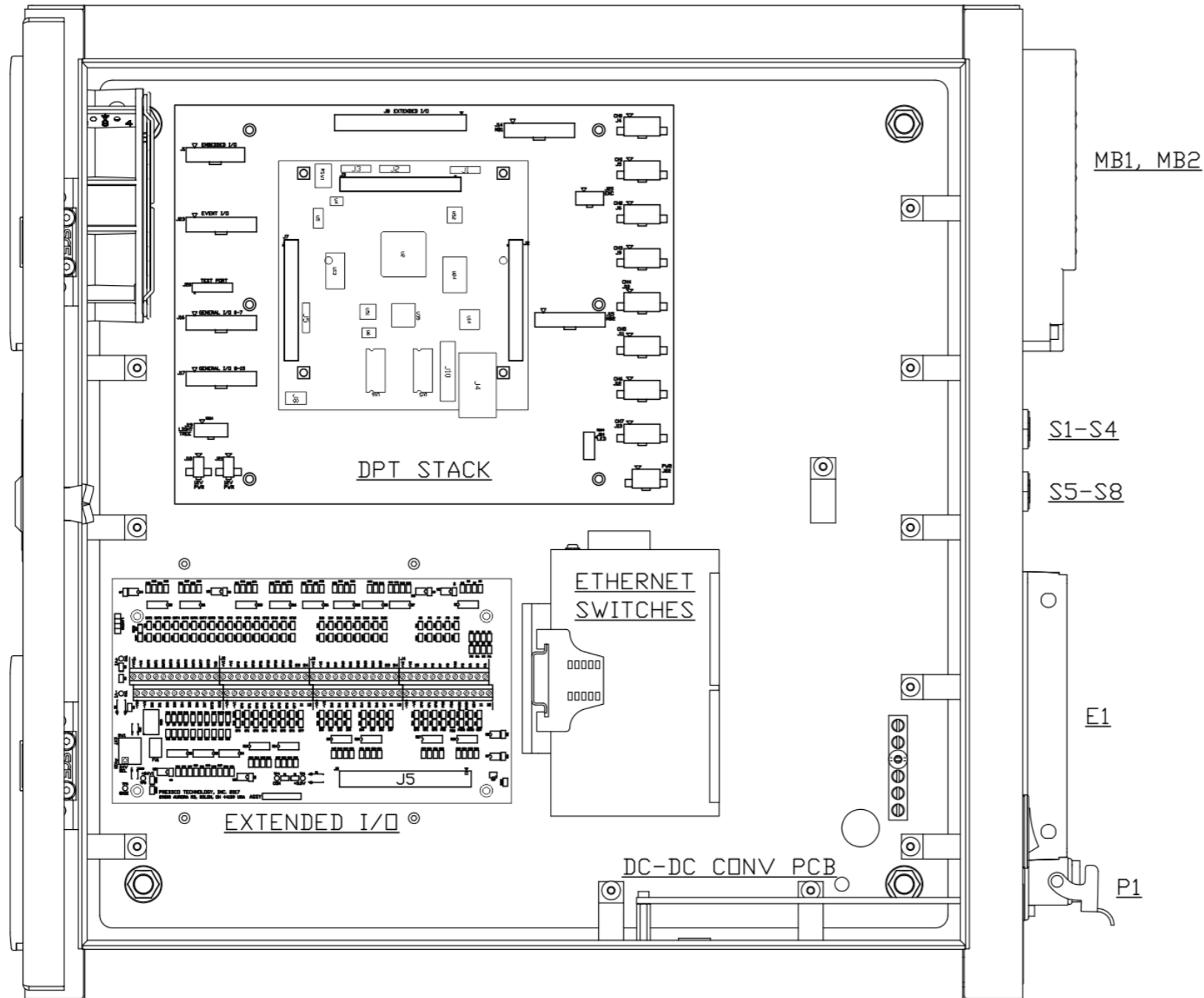

ENCLOSURE LABEL
SEE PROJECT ENGINEER FOR SYSTEM NUMBER AND PART NUMBER.

Model: ASSY CLUSTER BOX 8CH S6	
System Number: XXXXX	Volts: 60VDC
Part Number: XXXXX	Watts: 300
Enclosure Type: 12	
Year of Construction: XXXXX	
Electrical Diagram: F1920W	
PRESSCO Technology, Inc	29200 Aurora Road Solon, Ohio 44139 440-498-2600 www.pressco.com
	Made in USA

This page left blank intentionally

Chapter 7 Maintenance for the Cluster Box

Maintenance Cautions

When carrying out maintenance or repair work:



Disconnect master switch. For switch locations, refer to the Power Up and Power Down section.



Before starting the machine, ensure that no person is close to the machine.



If maintenance or repair requires the disconnection or removal of safety or protection systems, this operation must be supervised by authorized personnel who must ensure the prevention of personal injury or damage to the machine. All machine movements must be performed with limited speed and limited movements.



Maintenance or repair work on electrical components must be carried out exclusively by authorized, trained personnel. When running tests with power connected, you must strictly comply with the rules provided.



Personnel working on higher parts of a machine must wear a harness and hook it on to the structure and must always move with extreme caution.



Never perform lubrication or maintenance procedures on mechanical parts with the machine running.

LED Caution:



CAUTION - Possible hazardous optical radiation from LEDs. Do not stare at lamps.

Clean the Cluster Box Filters

If you do not have replacement filters, clean them once per month. Remove the covers to access the filters.

- If the filter contains only dry dust and dirt, rinse it in plain water
- If it contains oily dust and dirt, clean it in soapy water
- Dry the filter completely before reinstalling it

